

History of Deltai Medical Manufacture Group

In 1918, Lu Ying established Triad Trading Company, and he is David Lu's grandfather. In 1952, David Lu's father Lu, Ting - fou took over the company and changed the company business from trading to forage production. In 1970, during David Lu's tenure, the company business gradually developed from initial plastic processing to medical orthopedic products manufacture. Now the Group is run by the fourth successor - Tony Lu. Triad Orthopedic Products Industrial Co., Ltd. owns a capital of 112.6 million TWD and an area of 9.802 m². All those contribute to the foundation of Deltai International Medical Group being the leader in the field of medical products in Taiwan.

In 1972, Deltai Medical Group was established in Taiwan. As a professional manufacturer in the field of medical products, we have been forging ahead with our unremitting endeavor and keeping steady development in the business. Now the major products of the Group contains: the orthopedic products; CPM; EMS Products; Self-service Assistance and Daily Living Care Aids; Medical Compression Stockings and Garments; Animal Orthopedic Rehabilitation Series Products and Physical Therapy Products.

In 1992, we established the first factory in the mainland of China which is Deltai Medical & Health Articles (Suzhou) Co., Ltd. with registered capital of USD 8 million and an area of 20.000 m². It mainly manufactures orthopedic products; Self-service Assistance and Daily Living Care Aids; Medical Compression Stockings and Garments.

In 2002, to cover the gradually increased purchasing orders and provide more comprehensive medical products, we established the second factory in the mainland of China which is David Medical Products (Suzhou) Co., Ltd. with registered capital of USD 10 million and an area of 35.000 m². It mainly manufactures EMS Products and Orthopedic Products, supplying the most comprehensive series of EMS Products in China.

In 2011, we established Deltai Medical Group Office of China Business in Taicang, China.

In 2011, with the increase of purchasing orders, product varieties and the extension of production scale, Deltai Medical Group invested to build the third factory in the mainland of China which is Deltai Medical Products (Chuzhou) Co., Ltd. with USD 12 million in registered capital and an area of 56.300 m², mainly manufacturing Orthopedic Products.

In 2012, for greater competitiveness, more convenient communication and better production management integration between the two factories, Deltai Medical and David Medical achieved the corporate combination after being ratified by the local government; both generally called Deltai Medical & Health Articles (Suzhou) Co., Ltd. and respectively called Deltai Medical & Health Articles (Suzhou) Co., Ltd. - Deltai Medical Plant and Deltai Medical & Health Articles (Suzhou) Co., Ltd. - David Medical Plant. The registered capital is USD 18 million. We are certified ISO 9001:2008 and ISO 13485:2012 by TUV and already got People's Republic of China Registration Certificate for Medical Device in more than 100 varieties of medical products.

In 2012, Deltai Medical Group Head Office moved to Tainan, Taiwan with an area of 1.584 m².

At Deltai our focus is clear, and we are committed to what Deltai stands for: Quality, Service, and Professionalism. Starting from innovative design to select the finest materials to highest standards of quality control, every effort is devoted to ensure best products are provided for you and so that they can be passed on to satisfy your customers. We manufacture the most complete line of orthopedic products in the world with a high self-production capacity. We own over 1000 kinds of different products. There are over 3000 kinds of raw materials in the warehouse, totally worth 12 million or more. This is the basis on which we can offer the products you need in the shortest time. Furthermore, we provide fast and safe delivery for your orders. All these make Deltai Medical Group one of the world-famous, Asia-best and first-chair company.

We have the following facilities:

- 1. Laminating, Stamping, Trimming, Cutting and Automatic Cutting Table Plant*
- 2. Hollow Molding, Extruder, Various Plastic Injection Molding, Two-liquid Organic Silicon Injection Molding, Two-liquid PU Injection Molding, Injection Molding, Blow Molding, Vacuum Molding, Heat Press Molding and Cold Press Molding Plant*
- 3. Organic Silicon Products and Polysheet Splinting Material Plant*
- 4. Textile plant with more than 100 machines from domestic and overseas, including the knitting machine from Switzerland, Germany and Italy with medical purpose.*
- 5. All the devices that a tooling and metal process center should have (such as wire-cutting machines, electric discharge machines, grinder, milling machine, CNC milling machine(machining center), lathe, CNC lathe, radial drilling machines, vertical drilling machines, CNC water jet cutting machine, sawing machines, 3D printer, 3D scanner and so on.)*
- 6. CAD, CAM, CAE system center*
- 7. Orthopedic Soft-goods Plant*
- 8. Orthopedic Shoe Plant*
- 9. EMS Products Plant*
- 10. Self-service Assistance and Daily Living Care Aids*
- 11. Animal Orthopedic Series Products and Health Care Products*

Deltai Medical Group is a family business which was established by our President - David Lu. Now, the Vice President - Tony Lu and the General Manager - Jack Lu are in charge of running the business.

Quality Service Professionalism

All kinds of Orthopedic Products, CPM, EMS Products, Self-service Assistance and Daily Living Care Aids, Medical Compression Stockings and Garments, Animal Orthopedic Rehabilitation Series Products and Physical Therapy Products. Deltai Medical Group is one of the world-famous large-scale manufacturers in the medical products field.

Head Office in Taiwan (Taiwan)

Since 1972 in Taiwan



Office building
(the fifth floor):
1.584 m²

Office Of China Business (Taicang China)

Since 2007 in China

Office building: 5.300 m²



Triad Orthopedic Products Industrial Co., Ltd. (Taiwan)

Since 1918 in Taiwan

Manufacturer building: 9.802 m²

FDA(USA) registration No: 3009762043



Deltai Medical & Health Articles (Suzhou) Co., Ltd. Deltai Medical Plant (Taicang China)

Since 1972 in Taiwan, since 1992 in China

Manufacturer building: 20.000 m²

FDA(USA) registration No: 9616984



Deltai Medical & Health Articles (Suzhou) Co., Ltd. David Medical Plant (Taicang China)

Since 2002 in China

Manufacturer building: 35.000 m²

FDA(USA) registration No: 9616984



Deltai Medical Products (Chuzhou) Co., Ltd (Chuzhou China)

Since 2011 in China

Manufacturer building: 56.300 m²

FDA(USA) registration No: 3010391334



TUV ISO 9001: 2008
CERTIFICATED
No.: 12 100 37156 TMS



TUV ISO 13485:2012
CERTIFICATED
No.: QIN 15 08 70715 003



TUV ISO 9001:2015
CERTIFICATED
No.: TUV100 02 3479



VERSION 2008
NO.: 12 100 37156 TMS



VERSION 2012
NO.: QIN 15 08 70715 003



VERSION 2015
NO.: TUV100 02 3479

To Honorable Customers,

People want world peace, to be away from the war, to have mutual respect and to love each other. In addition, it is of equal importance to maintain the natural harmony. Animals are human's most intimate friends. We should love animals and cherish their lives.

The treatment and the application of rehabilitation products, as well as physical therapy, for human skeletal and joints injuries are not only universal but also professionally completed. However, the development of orthopedic rehabilitation and physical therapy products for animals, such as dogs, cats and horses, is many years behind the one of humans. The International Association of Veterinary Rehabilitation and Physical Therapy was founded in July, 2008. From then on, veterinarians all around the world had the chance to communicate and cooperate with others. In 2010, the Veterinary European Physical Therapy and Rehabilitation Association firstly held a conference to communicate and cooperate, followed by America establishing the American Association of Rehabilitation Veterinarians. Finally, the veterinarians had the chance to exchange information, research and develop, educate and experiment on animal products, pushing the European and American markets to grow and mature. On the other side, the development of animal products in Asian countries is still groping in the dark. We, the Deltai Medical Group, as a world-famous professional orthopedic medical products manufacturer, are willing to do our part in the field of research and development, education and experiment on animal (dogs, cats, horses, and etc.) rehabilitation and physical therapy products, to make ourselves the first professional animal products developer and manufacturer in Asia. At Deltai Medical Group, we started research and development, manufacture, and sale of human orthopedic products as early as 1972. After decades of development, we now own advanced technology, rich experience, and a deep understanding of the human body. And we are willing to apply what we have on human products to animal products. Triad Orthopedic Products Industrial Co., Ltd was established in 1918. As a member of Deltai Medical Group, it took the responsibility and started the research of animal orthopedic products in 2014. The research results go into production successfully in the affiliated plants in Taiwan and China mainland, covering the shortage of rehabilitation and physical therapy products for dogs, cats and horses in Asia. We sell the animal products to the whole world with our own brand  , and we believe our professional products will satisfy you. We were praised for our innovation and good quality products. We greatly appreciate if you speak highly of our qualified team and excellent employees.

Professional advice from domestic and overseas veterinarians is very welcome here. Further cooperation on new techniques and products can be carried out if you are interested. For more information about our products, please visit our website: www.com.triad-orthopedic.com. Products marked with  or  are used for dogs and cats. And products marked with  go for horses.

If you are a veterinarian, please contact the agent in your region to buy our products, or send an email to our headquarter in Taiwan (Email: export@deltai.com.tw Tel: +886-6-2682277) to reach the agent in your region. If you are an animal owner, please contact your professional veterinary hospital to buy the products on behalf of you. We don't offer products to animal owners directly. Our products should be used with professional veterinarians' direction, correct measurement, and right size based on the indication on the catalogue.

If you would like to be our sole distributor in your country to serve local veterinarians, please contact us. Don't miss your chance.

Deltai Medical Group



Vice President Tony Lu

Main Products

TABLE OF CONTENT

Dog & Cat Orthopedic Rehabilitation Series Products	
<i>Ear Wrap, Cervical Support</i>	3
<i>Body Holder, Walking Assistance, Floatable Body Coat</i>	4-7
<i>Shoulder Brace, Hip Brace</i>	8-11
<i>Elbow Brace / Splint, Knee Brace / Splint, Adjustable Elbow / knee Splint</i>	12-14
<i>Carpal Walker / Splint, Hock Walker / Splint</i>	15-19
<i>Bendable Carpal / Hock Brace, Elastic Paw Sling</i>	20-22
<i>Dorsi-Flex Assist, Wheeled Orthosis</i>	22-23
<i>Protective Forelimb / Hindlimb Prosthesis</i>	24-25
<i>Footwear</i>	26-27
<i>Walking Assistance (Wheelchair)</i>	28-30
Animal Hospital / Clinic Appliances	31
Physical Therapy Products	
<i>Inflatable Ball, Paw Pods</i>	32-33
<i>Fourwheel Sliding Board, Balance Board</i>	34
<i>Agility Exercise Kit, Exercise Support, Cool/Hot Wrap, Weighted Vest / Wrap</i>	35-36
Horse Orthopedic Rehabilitation Series Products	
<i>Ear Bonnet, Cervical Collar, Body Blanket, Back Pad</i>	38
<i>Hock Wrap</i>	38-39
<i>Fetlock Wrap, Fetlock Boot, Protective Hoof Wrap</i>	39-41
Purchase and Use Directions for Veterinarians	42

Quality Service Professionalism

Breeds of dogs:

A	E	F	H	I
Chihuahua Chinese Crested Maltese Poodle(Toy)	American Eskimo Australian Terrier Bichon Frise Border Collie Border Terrier Boston Terrier Bull Terrier(Mini) Cairn Terrier French Bulldog Havanese Irish Terrier Jack Russell Terrier Lakeland Terrier Lhasa Apso Manchester Terrier Norfolk Terrier Parson Jack Russell Terrier Pembroke Welsh Corgi Petit Basset Griffon Poodle Pug Sealyham Terrier Shetland Sheepdog Shiba Inu Shitzu Silky Terrier Skye Terrier Smooth Fox Terrier Schnauzer(Mini) West Highland White Terrier Wire Fox Terrier	Beagle Chinese Shari Pei Cocker Spaniel	Bulldog	Airedale Basset Hound Bearded Collie Bloodhound Irish Wolfhound Kerry Blue Terrier Labrador Retriever Puli Rottweiler
B		G		J
Brussels Griffon Cavalier King Charles Dachshund Italian Greyhound Miniature Pinscher Papillion Pekingese Pomeranian Toy Fox Terrier		Afghan Hound Akita Alaskan Malamute American Stafford Terrier American Water Spaniel Basenji Belgian Malinois Boxer Brittany Bull Terrier(Standard) Cardigan Welsh Corgi Chow Chow Collie Dalmatian Dandie Dinmont Terrier Doberman Pinscher English Cocker Spaniel English Foxhound English Springer Spaniel Field Spaniel German Pinscher	German Shepherd Dog Golden Retriever Greyhound Irish Setter Lowchen Nova Scotia Duck - Tolling Retriever Pit Bull Poodle(Standard) Portuguese Water Dog Rhodesian Ridgeback Soft Coated Wheaten Schnauzer(Standard) Scottish Terrier Terrier Staffordshire Bull Terrier Swedish Vallhund Tibetan Terrier Welsh Springer Spaniel Weimaraner Whippet	Bernese Mountain Dog
C				K
American Eskimo(Mini fenpinscher) Japanese Chin Schipperke				English Toy Spaniel Great Dane Great Pyrenees Mastiff Newfoundland Old English Sheepdog Schnauzer(Giant) St. Bernard
D				
English Toy Spaniel				

Please find above a list of dog breeds for your convenience. They are sorted into 11 categories in the order of dog style. Dogs in category B are bigger than A and smaller than C. The rest can be referred to the same manner, A<B<C<D<E<F<G<H<I<J<K.

A, B, C, D: small-style dogs E, F, G, H: medium-style dogs I, J, K: big-style dogs

To ensure the suitable size choice for your dog, please measure your dog accordingly, and refer to the measurements we state.

Anatomical picture for dog:

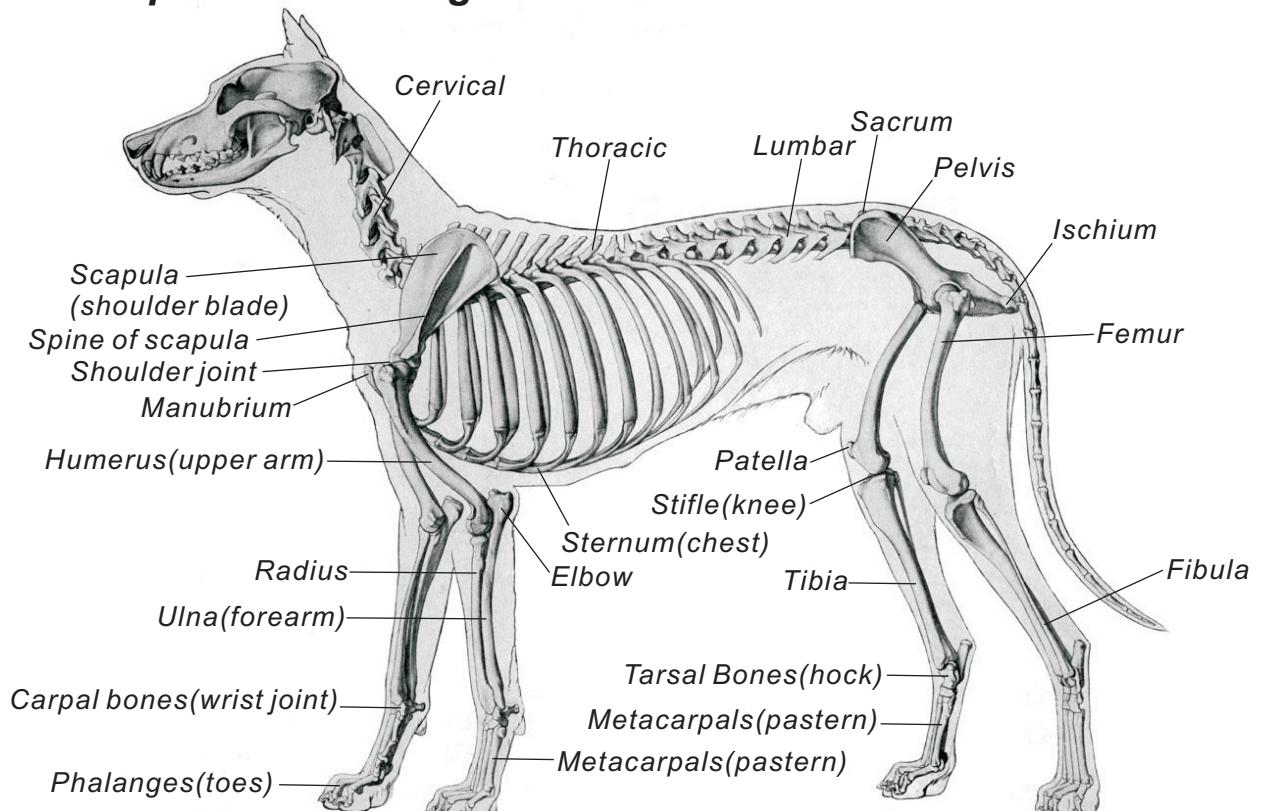

Breeds of cats (CFA reference standard) :

A	B		C
<i>Singapura</i> <i>Cornish Rex</i> <i>Oriental Cat</i>	<i>Siamese Cat</i> <i>Scottish Fold</i> <i>British Shorthair</i> <i>Persian cat</i> <i>Russian Blue,</i> <i>Exotic Shorthair</i> <i>Norwegian Forest Cat</i> <i>Egyptian Mau</i> <i>Birman cat</i> <i>Canadian Hairless</i> <i>Burmese</i> <i>Abyssinian Cat</i> <i>Turkish Van</i> <i>American Bobtail</i>	<i>Japanese Bobtail</i> <i>Balinese cat</i> <i>Ragamuffin Cat</i> <i>Tonkinese</i> <i>Cornish Rex</i> <i>Manx Cat</i> <i>Ocel-lette</i> <i>Devon Rex</i> <i>American Wirhair</i> <i>Havana Brown</i> <i>Colorpoint Shorthair</i> <i>Selkirk Rex</i> <i>American Rex</i>	<i>Ragdoll</i> <i>British Shorthair</i> <i>Persian cat</i> <i>American Shorthair</i> <i>Chartreux cat</i>

Please find above a list of cat breeds for your convenience. They are sorted into 3 categories in the order of cat style. Cats in category B are bigger than A and smaller than C. That is $A < B < C$.

To ensure the suitable size choice for your cat, please measure your cat accordingly, and refer to the measurements we state.

Anatomical picture for cat:

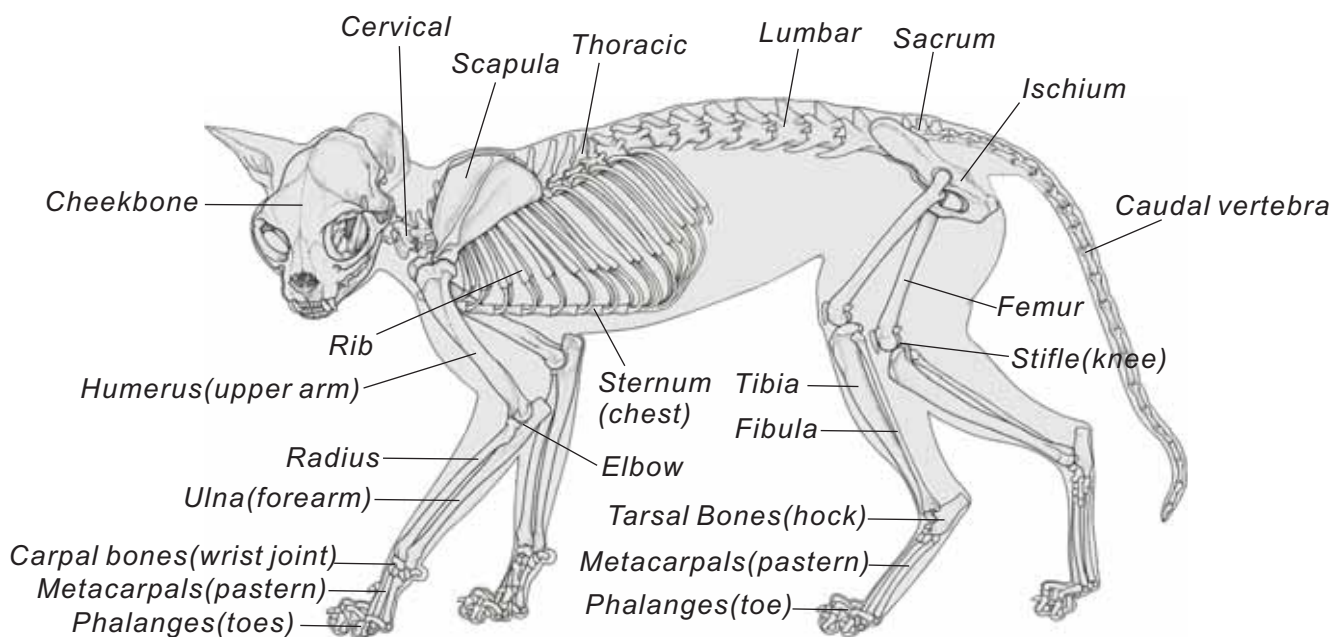



Suspended Rehabilitation Chest Holder

- .Fixation assistance harness for dogs in recovery from thoracic cage and thoracic cavity injuries.
- .Fix and support animal's chest, thoracic vertebra and thoracic cavity, and relieve pain.
- .Bendable plastic plate inside and breathable spacer fabric lining outside conform to dog's chest contour, forming a strong shell to protect dog's chest.
- .Lifting dogs with forelimb weakness, relieving the weight stress on ligament and tendon.

Code	Size	Chest girth	Upper arm girth	Bearing weight	Code	Size	Chest girth	Upper arm girth	Bearing weight
<i>medium-style dogs</i>					<i>small-style dogs</i>				
T-10013	S	50-56cm	21-24cm	20kg	T-10112	XS	30-34cm	8-11cm	10kg
T-10014	S/M	57-63cm	24-27cm	30kg	T-10113	S	35-39cm	12-15cm	10kg
T-10015	M	64-71cm	27-31cm	50kg	T-10115	M	40-44cm	16-19cm	15kg
T-10016	M/L	72-80cm	31-35cm	70kg	T-10117	L	45-50cm	19-22cm	20kg
T-10017	L	81-90cm	35-40cm	80kg					
T-10018	XL	90-100cm	40-45cm	80kg					



Suspended Rehabilitation Hip Holder

- .Fixation assistance harness for dogs in recovery from pelvis and sacrum injuries.
- .Keep the warmth of animal's pelvis and hip joint, and relieve pain.
- .Made of breathable spacer fabric; hip contoured design provides comfortable fit.
- .Lifting holder helps to sling dogs with uncoordinated movement or muscle weakness caused by hip dysplasia or osteoarthritis.

Code	Size	Belly girth	Upper leg girth	Bearing weight	Code	Size	Belly girth	Upper leg girth	Bearing weight
<i>medium-style dogs</i>					<i>small-style dogs</i>				
T-11013	S	38-47cm	22-28cm	30kg	T-11112	XS	28-32cm	9-13cm	10kg
T-11015	M	48-59cm	28-36cm	50kg	T-11113	S	30-34cm	13-17cm	10kg
T-11017	L	60-72cm	36-44cm	70kg	T-11115	M	32-36cm	16-20cm	15kg
T-11018	XL	73-85cm	44-52cm	80kg	T-11117	L	34-38cm	20-25cm	20kg



Suspended Thermal Chest Holder

- .Thermal coat for dogs in recovery from thoracic cage and thoracic cavity injuries.
- .Thermal, soft and breathable; buckle strap allows quick closure and release.
- .Lifting holder helps to sling dogs with forelimb weakness, relieving the stress on ligament and tendon.
- .Protect the glenohumeral ligaments; help the animal to keep balance after operation; good for animal's recovery.

Code	Size	Chest girth	Upper arm girth	Bearing weight	Code	Size	Chest girth	Upper arm girth	Bearing weight
<i>medium-style dogs</i>					<i>small-style dogs</i>				
T-12013	S	50-61cm	21-26cm	30kg	T-12112	XS	30-34cm	8-11cm	10kg
T-12015	M	62-74cm	27-32cm	50kg	T-12113	S	35-39cm	12-15cm	10kg
T-12017	L	75-87cm	33-39cm	70kg	T-12115	M	40-44cm	16-19cm	15kg
T-12018	XL	88-100cm	39-45cm	80kg	T-12117	L	45-50cm	19-22cm	20kg



Suspended Thermal Hip Holder



- .Thermal coat for dogs in recovery from pelvis and sacrum injuries.
- .Thermal, soft and breathable; buckle strap allows quick closure and release.
- .Lifting holder helps to sling dogs with uncoordinated movement or muscle weakness caused by hip dysplasia or osteoarthritis.
- .Protect the hip; help the animal to keep balance after operation; good for animal's recovery.

Code	Size	Belly girth	Upper leg girth	Bearing weight	Code	Size	Belly girth	Upper leg girth	Bearing weight
<i>medium-style dogs</i>					<i>small-style dogs</i>				
T-13013	S	38-47cm	22-28cm	30kg	T-13112	XS	28-32cm	9-13cm	10kg
T-13015	M	48-59cm	28-36cm	50kg	T-13113	S	30-34cm	13-17cm	10kg
T-13017	L	60-72cm	36-44cm	70kg	T-13115	M	32-36cm	16-20cm	15kg
T-13018	XL	73-85cm	44-52cm	80kg	T-13117	L	34-38cm	20-25cm	20kg



Handling Rehabilitation Body Holder



- .Fixation assistance harness for dogs in recovery from thoracic cage injuries, thoracic cavity injuries, and thoracolumbar spine injuries.
- .Bendable plastic plate conforms to dog's chest and abdomen contour, forming a strong shell to support thoracolumbar spine and thoracic cavity.
- .Lifting dogs with limb weakness, relieving the weight stress on ligament and tendon.

Code	Size	Body length	Chest girth	Bearing weight	Code	Size	Body length	Chest girth	Bearing weight
<i>medium-style dogs</i>					<i>small-style dogs</i>				
T-14013	S	41-45cm	50-61cm	30kg	T-14112	XS	25-29cm	30-34cm	10kg
T-14015	M	45-50cm	62-74cm	50kg	T-14113	S	29-33cm	35-39cm	10kg
T-14017	L	50-55cm	75-87cm	70kg	T-14115	M	33-37cm	40-44cm	15kg
T-14018	XL	55-60cm	88-100cm	80kg	T-14117	L	37-41cm	45-50cm	20kg

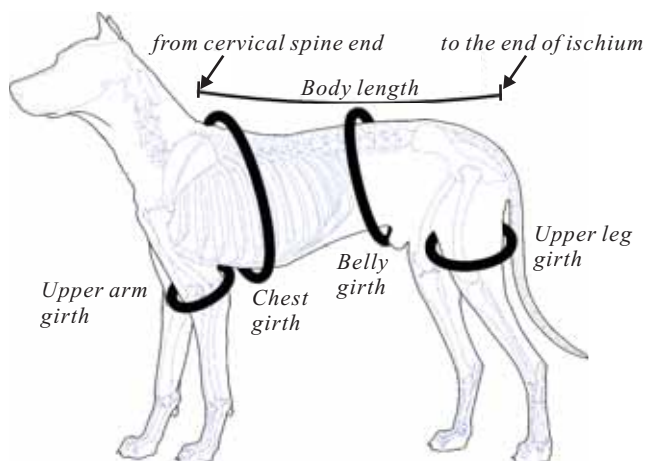

Measurement instruction



small-style dogs

Suspended Walking Assistance Harness



.Assist dogs with weak hip or leg in walking, lessen the stress on muscle.
.Protect the animal's glenohumeral ligaments and hip joint, relieving the weight stress on them.
.Breathable mesh lining for comfortability, colorful fabric for good look.



medium-style dogs

Handling Walking Assistance Harness



.Assist dogs with weak hip or leg in walking, lessen the stress on muscle.
.Protect the animal's glenohumeral ligaments and hip joint, relieving the weight stress on them.
.Breathable mesh lining for comfortability, brushed fabric for good warmth.
.Provided with strong handle strap and shoulder strap for better sling.

Code	Size	Body length	Chest girth	Bearing weight
<i>small-style dogs</i>				
T-16112	XS	25-29cm	30-34cm	10kg
T-16113	S	29-33cm	35-39cm	10kg
T-16115	M	33-37cm	40-44cm	15kg
T-16117	L	37-41cm	45-49cm	20kg
T-16118	XL	41-45cm	48-59cm	30kg

Code	Size	Body length	Chest girth	Bearing weight
<i>medium-style dogs</i>				
T-16213	S	41-45cm	50-61cm	30kg
T-16215	M	45-50cm	62-74cm	50kg
T-16217	L	50-55cm	75-87cm	70kg
T-16218	XL	55-60cm	88-100cm	80kg



Suspended Walking Assistance Harness



.Help the dogs with weak hip or limbs to walk.
.For the dogs in recovery or with tendon injuries.
.Protect the animal's glenohumeral ligaments and hip joint, relieving the weight stress on them.
.Buckle closures allow quick closure and release.
.U-design on the belly makes excretion easy.

Code	Size	Carpal girth	Belly girth	Bearing weight
<i>medium-style dogs</i>				
T-16313	S	50-70cm	40-55cm	30kg
T-16315	M	60-80cm	50-65cm	50kg
T-16317	L	70-90cm	60-75cm	70kg
T-16318	XL	80-100cm	70-85cm	80kg



Handling Floatable Body Coat



.Made of floatable material to help dog float on water.
.Hidden and sealed buckle closures on neck and abdomen maximumly keep dog's safety.
.Reflective stripes offer increased visibility to position the dog.
.Keep the animal's warmth when taking exercise in water.

Code	Size	Body length	Chest girth	Bearing weight
<i>medium-style dogs</i>				
T-17013	S	40-44cm	50-56cm	10kg
T-17014	S/M	42-46cm	57-63cm	20kg
T-17015	M	45-49cm	64-71cm	30kg
T-17016	M/L	48-52cm	72-80cm	30kg
T-17017	L	52-56cm	81-90cm	40kg
T-17018	XL	56-60cm	90-100cm	50kg

Code	Size	Body length	Chest girth	Bearing weight
<i>small-style dogs</i>				
T-17112	XS	25-29cm	30-34cm	10kg
T-17113	S	29-33cm	35-39cm	10kg
T-17115	M	33-37cm	40-44cm	15kg
T-17117	L	37-41cm	45-50cm	20kg



medium-style dogs



small-style dogs, cats



small-style dogs, cats

Code	Size	Chest girth	Upper arm girth
<i>medium-style dogs</i>			
	left right		
T-18013	T-18023	S 40-54cm	20-24cm
T-18015	T-18025	M 54-78cm	24-28cm
T-18017	T-18027	L 78-107cm	28-32cm

Code	Size	Chest girth	Upper arm girth
<i>small-style dogs, cats</i>			
	left right		
T-18112	T-18122	XS 32-36cm	8-11cm
T-18113	T-18123	S 34-38cm	11-14cm
T-18115	T-18125	M 36-40cm	14-17cm
T-18117	T-18127	L 38-46cm	17-20cm

Adjustable Shoulder Brace



.Assistance brace for forelimb paresis, shoulder arthritis; reduction of shoulder joint dislocation; rehabilitation of humerus fracture and shoulder joint injuries.
.Adjustable range of motion allows fixation and support of humerus and scapula at a desired angle.
.Bendable inner plastic plate on upper arm provides strong fixation to humerus.
.Fix and support the animal; adjust and correct gait; relieve the pain.



medium-style dogs



small-style dogs, cats

Adjustable Double-limb Shoulder Brace



.Assistance brace for forelimb paresis, shoulder arthritis; reduction of shoulder joint dislocation; rehabilitation of humerus fracture and shoulder joint injuries.
.Adjustable range of motion allows fixation and support of humerus and scapula at a desired angle.
.Bendable inner plastic plate on upper arm provides stronger fixation to humerus; breathable spacer fabric lining allows air circulation even in hot summer, animals can recover better.
.Designed with two arms' braces which both can be optionally used when needed.
.Fix and support the animal; adjust and correct gait; relieve the pain.

Code	Size	Chest girth	Upper arm girth
<i>medium-style dogs</i>			
T-18053	S	40-54cm	20-24cm
T-18055	M	54-78cm	24-28cm
T-18057	L	78-107cm	28-32cm

Code	Size	Chest girth	Upper arm girth
<i>small-style dogs, cats</i>			
T-18152	XS	32-36cm	8-11cm
T-18153	S	34-38cm	11-14cm
T-18155	M	36-40cm	14-17cm
T-18157	L	38-46cm	17-20cm

Measurement instruction

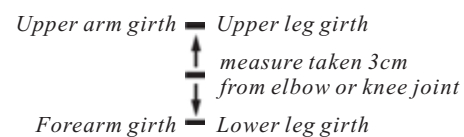
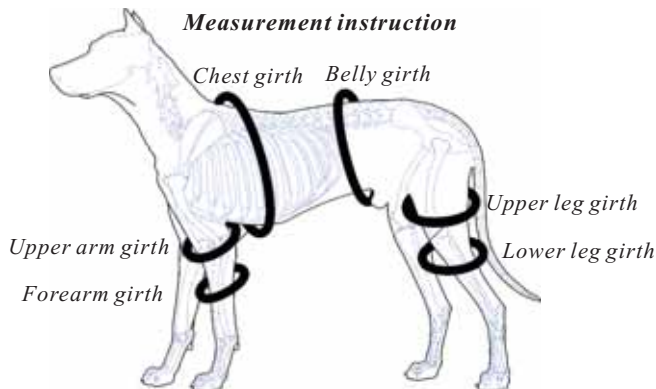

Taiwan Patent
China Patent



medium-style dogs

Taiwan Patent
China Patent



small-style dogs, cats

Adjustable Shoulder-to-wrist Brace



- .Assistance brace for forelimb paresis; reduction of shoulder joint dislocation; correction of forelimb deformities.
- .Assistance brace for rehabilitation of shoulder joint, elbow joint and carpal joint injuries, humerus and forearm injuries.
- .Adjustable range of motion allows fixation and support to animal's forelimb at desired angles during each recovery period.
- .Bendable inner plastic plate on upper arm provides stronger fixation to humerus; breathable spacer fabric lining allows air circulation even in hot summer, animals can recover better.
- .Fix and support the animal; adjust and correct gait; relieve the pain.
- .T-18132 XS & T-18142 XS, for small-style dogs and cats, are not designed with adjustable length because of too small sizes.**

Code	Size	Chest girth	Upper arm girth	Forearm girth
<i>medium-style dogs</i>				
<i>left</i>	<i>right</i>			
T-18033	T-18043	S	40-54cm	20-24cm 12-14cm
T-18035	T-18045	M	54-78cm	24-28cm 14-16cm
T-18037	T-18047	L	78-107cm	28-32cm 16-20cm

Code	Size	Chest girth	Upper arm girth	Forearm girth
<i>small-style dogs, cats</i>				
<i>left</i>	<i>right</i>			
T-18132	T-18142	XS	32-36cm	8-11cm 6-8cm
T-18133	T-18143	S	34-38cm	11-14cm 7-9cm
T-18135	T-18145	M	36-40cm	14-17cm 8-10cm
T-18137	T-18147	L	38-46cm	17-20cm 10-12cm

Taiwan Patent
China Patent



medium-style dogs

Taiwan Patent
China Patent



small-style dogs, cats

Adjustable Double-limb Shoulder-to-wrist Brace



- .Assistance brace for forelimb paresis; reduction of shoulder joint dislocation; correction of forelimb deformities.
- .Assistance brace for rehabilitation of shoulder joint, elbow joint and carpal joint injuries, humerus and forearm injuries.
- .Adjustable range of motion allows fixation and support to animal's forelimb at desired angles during each recovery period.
- .Bendable inner plastic plate on upper arm provides stronger fixation to humerus; breathable spacer fabric lining allows air circulation even in hot summer, animals can recover better.
- .Designed with two arms' braces which both can be optionally used when needed.
- .Fix and support the animal; adjust and correct gait; relieve the pain.
- .T-18162 XS, for small-style dogs and cats, are not designed with adjustable length because of too small sizes.**

Code	Size	Chest girth	Upper arm girth	Forearm girth
<i>medium-style dogs</i>				
T-18063	S	40-54cm	20-24cm	12-14cm
T-18065	M	54-78cm	24-28cm	14-16cm
T-18067	L	78-107cm	28-32cm	16-20cm

Code	Size	Chest girth	Upper arm girth	Forearm girth
<i>small-style dogs, cats</i>				
T-18162	XS	32-36cm	8-11cm	6-8cm
T-18163	S	34-38cm	11-14cm	7-9cm
T-18165	M	36-40cm	14-17cm	8-10cm
T-18167	L	38-46cm	17-20cm	10-12cm

Measurement instruction

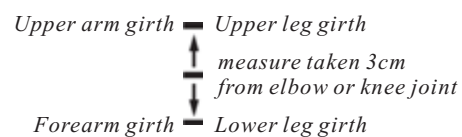
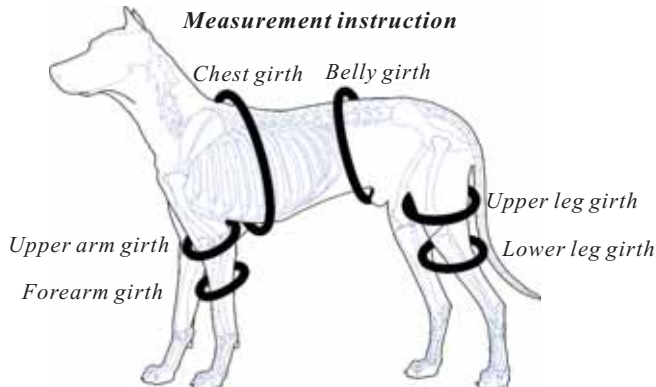



medium-style dogs



small-style dogs, cats



Code	Size	Belly girth	Upper leg girth
------	------	-------------	-----------------

medium-style dogs

left right

T-19013	T-19023	S	38-53cm	22-28cm
T-19015	T-19025	M	53-68cm	28-36cm
T-19017	T-19027	L	68-85cm	36-44cm

Code	Size	Belly girth	Upper leg girth
------	------	-------------	-----------------

small-style dogs, cats

left right

T-19112	T-19122	XS	28-32cm	9-13cm
T-19113	T-19123	S	30-34cm	13-17cm
T-19115	T-19125	M	32-36cm	16-20cm
T-19117	T-19127	L	34-38cm	20-25cm

Adjustable Hip Brace



.Assistance brace for hindlimb paresis; hip arthritis; reduction of hip joint dislocation; rehabilitation of femur fracture and hip joint injuries.

.Adjustable range of motion allows fixation and support of hip bone and femur at a desired angle.

.Bendable inner plastic plate on upper leg provides strong fixation to femur.

.Fix and support the animal; adjust and correct gait; relieve the pain.



medium-style dogs



small-style dogs, cats

Adjustable Double-limb Hip Brace



.Assistance brace for hindlimb paresis, hip arthritis; reduction of hip joint dislocation; rehabilitation of femur fracture and hip joint injuries.

.Adjustable range of motion allows fixation and support of hip bone and femur at a desired angle.

.Bendable inner plastic plate on upper leg provides stronger fixation to humerus; breathable spacer fabric lining allows air circulation even in hot summer, animals can recover better.

.Fix and support the animal; adjust and correct gait; relieve the pain.

.Designed with two legs' braces which both can be optionally used when needed.

Code	Size	Belly girth	Upper leg girth
------	------	-------------	-----------------

medium-style dogs

T-19053	S	38-53cm	22-28cm
T-19055	M	53-68cm	28-36cm
T-19057	L	68-85cm	36-44cm

Code	Size	Belly girth	Upper leg girth
------	------	-------------	-----------------

small-style dogs, cats

T-19152	XS	28-32cm	9-13cm
T-19153	S	30-34cm	13-17cm
T-19155	M	32-36cm	16-20cm
T-19157	L	34-38cm	20-25cm

Measurement instruction

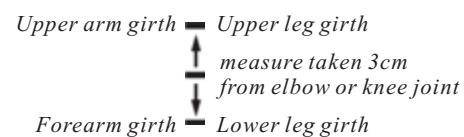
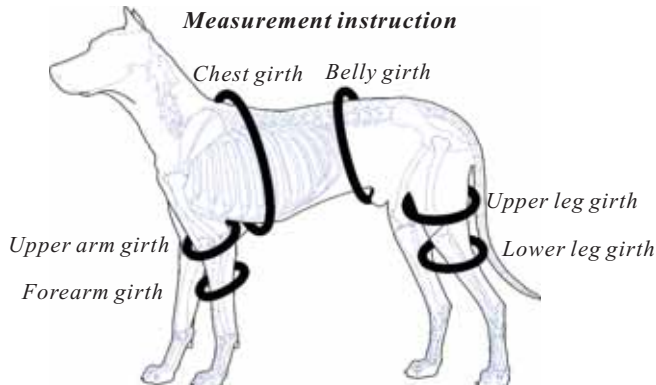

Taiwan Patent
China Patent



medium-style dogs

Taiwan Patent
China Patent



small-style dogs, cats

Adjustable Hip-to-ankle Brace



.Used on animal's hip, femur, knee, tibia, fibula, hock and metatarsals.
.Assistance brace for hindlimbs paresis, hip arthritis, knee arthritis and hock arthritis; reduction of joints dislocation; rehabilitation of femur fracture and hip joint injuries.
.Adjustable range of motion allows fixation and support to animal's hindlimbs always at a desired angle.
.Bendable inner plastic plate on upper leg provides stronger fixation to humerus.
.Fix and support the animal; adjust and correct gait; relieve the pain.
.T-19132 XS & T-19142 XS, for small-style dogs and cats, are not designed with adjustable length because of too small sizes.

Code	Size	Belly girth	Upper leg girth	Lower leg girth
<i>medium-style dogs</i>				
<i>left</i>	<i>right</i>			
T-19033	T-19043	S	38-53cm	22-28cm 10-14cm
T-19035	T-19045	M	53-68cm	28-36cm 14-19cm
T-19037	T-19047	L	68-85cm	36-44cm 19-24cm

Code	Size	Belly girth	Upper leg girth	Lower leg girth
<i>small-style dogs, cats</i>				
<i>left</i>	<i>right</i>			
T-19132	T-19142	XS	28-32cm	9-13cm 6-8cm
T-19133	T-19143	S	30-34cm	13-17cm 7-9cm
T-19135	T-19145	M	32-36cm	16-20cm 8-10cm
T-19137	T-19147	L	34-38cm	20-25cm 10-12cm

Taiwan Patent
China Patent



medium-style dogs

Taiwan Patent
China Patent



small-style dogs, cats

Adjustable Double-limb Hip-to-ankle Brace



.Used on animal's hip, femur, knee, tibia, fibula, hock and metatarsals.
.Assistance brace for hindlimbs paresis, hip arthritis, knee arthritis and hock arthritis; reduction of joints dislocation; rehabilitation of femur fracture and hip joint injuries.
.Adjustable range of motion allows fixation and support to animal's hindlimbs always at a desired angle.
.Bendable inner plastic plate on upper leg provides stronger fixation to humerus.
.Fix and support the animal; adjust and correct gait; relieve the pain.
.Designed with two hindlimbs' braces, both can be optionally used when needed.
.T-19162 XS, for small-style dogs and cats, are not designed with adjustable length because of too small sizes.

Code	Size	Belly girth	Upper leg girth	Lower leg girth
<i>medium-style dogs</i>				
T-19063	S	38-53cm	22-28cm	10-14cm
T-19065	M	53-68cm	28-36cm	14-19cm
T-19067	L	68-85cm	36-44cm	19-24cm

Code	Size	Belly girth	Upper leg girth	Lower leg girth
<i>small-style dogs, cats</i>				
T-19162	XS	28-32cm	9-13cm	6-8cm
T-19163	S	30-34cm	13-17cm	7-9cm
T-19165	M	32-36cm	16-20cm	8-10cm
T-19167	L	34-38cm	20-25cm	10-12cm

Measurement instruction

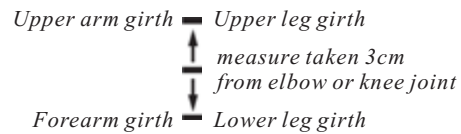
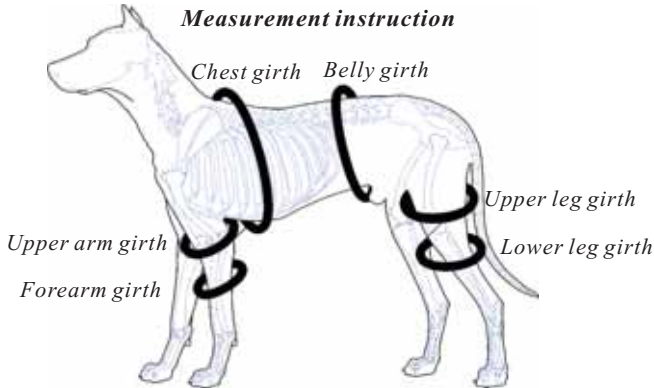



medium-style dogs



small-style dogs, cats



Adjustable Elbow Brace



*.Fixation brace for elbow joint injuries, fractures of humerus, radius and ulna; forelimb paresis and muscle strain; support of elbow arthritis.
 .Adjustable range of motion allows fixation and support of upper arm and forearm at a desired angle.
 .Superior and elastic space fabric allows comfortable movement of elbow.
 .Fix and support the animal; adjust and correct gait; relieve the pain.*

Code		Size	Upper arm girth	Forearm girth
<i>medium-style dogs</i>				
<i>left</i>	<i>right</i>			
T-20013	T-20023	S	20-24cm	12-14cm
T-20015	T-20025	M	24-28cm	14-16cm
T-20017	T-20027	L	28-32cm	16-20cm

Code		Size	Upper arm girth	Forearm girth
<i>small-style dogs, cats</i>				
<i>left</i>	<i>right</i>			
T-20112	T-20122	XS	8-11cm	6-8cm
T-20113	T-20123	S	11-14cm	7-9cm
T-20115	T-20125	M	14-17cm	8-10cm
T-20117	T-20127	L	17-20cm	10-12cm



medium-style dogs



small-style dogs, cats



Adjustable Knee Brace



*.Fixation brace for knee joint injuries, femur and tibiofibula fractures; hindlimb paresis and muscle strain; support of knee arthritis.
 .Adjustable range of motion allows fixation and support of upper leg and lower leg at a desired angle.
 .Superior and elastic space fabric allows comfortable movement of knee.
 .Fix and support the animal; adjust and correct gait; relieve the pain.*

Code		Size	Upper leg girth	Lower leg girth
<i>medium-style dogs</i>				
<i>left</i>	<i>right</i>			
T-25013	T-25023	S	25-31cm	12-15cm
T-25015	T-25025	M	31-37cm	15-19cm
T-25017	T-25027	L	37-44cm	19-24cm

Code		Size	Upper leg girth	Lower leg girth
<i>small-style dogs, cats</i>				
<i>left</i>	<i>right</i>			
T-25112	T-25122	XS	9-13cm	6-8cm
T-25113	T-25123	S	13-17cm	7-9cm
T-25115	T-25125	M	16-20cm	8-10cm
T-25117	T-25127	L	20-25cm	10-12cm



medium-style dogs



small-style dogs, cats

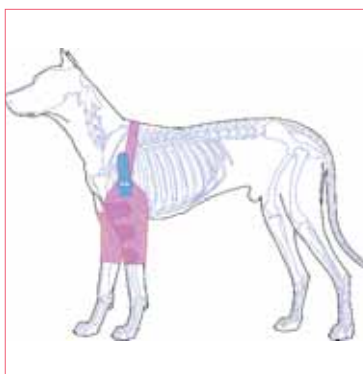

Elastic Elbow Brace

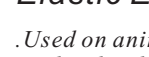

*.Used on animal's elbow, humerus and radioulna.
 .Protect animal from elbow injuries; prevent strain to forelimb muscle, tendon and ligament.
 .Superior elastic material allows comfortable movement of elbow; band connects two side braces through the back.
 .Fix and support the animal; relieve the pain.
 .Two kinds of material available: space fabric allows air flow, neoprene keeps warmth.*

Code		Size	Upper arm girth	Forearm girth
<i>medium-style dogs</i>				
<i>neoprene</i>	<i>spacer fabric</i>			
T-21053	T-21063	S	20-24cm	12-14cm
T-21055	T-21065	M	24-28cm	14-16cm
T-21057	T-21067	L	28-32cm	16-20cm

Code		Size	Upper arm girth	Forearm girth
<i>small-style dogs, cats</i>				
<i>neoprene</i>	<i>spacer fabric</i>			
T-21152	T-21162	XS	8-11cm	6-8cm
T-21153	T-21163	S	11-14cm	7-9cm
T-21155	T-21165	M	14-17cm	8-10cm
T-21157	T-21167	L	17-20cm	10-12cm



medium-style dogs



small-style dogs, cats

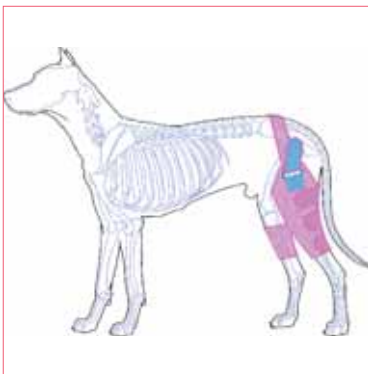

Elastic Knee Brace

- .Used on animal's knee, femur and tibiofibula.
- .Protect animal from knee injuries; prevent strain to hindlimb muscle, tendon and ligament.
- .Superior elastic material allows comfortable movement of knee; band connects two side braces through the back.
- .Fix and support the animal; relieve the pain.
- .Two kinds of material available: spacer fabric allows air flow, neoprene keeps warmth.

Code	Size	Upper leg girth	Lower leg girth	Code	Size	Upper leg girth	Lower leg girth
<i>medium-style dogs</i>				<i>small-style dogs, cats</i>			
neoprene	spacer fabric			neoprene	spacer fabric		
T-26053	T-26063	S	22-28cm	10-14cm	T-26152	T-26162	XS 9-13cm 6-8cm
T-26055	T-26065	M	28-36cm	14-19cm	T-26153	T-26163	S 13-17cm 7-9cm
T-26057	T-26067	L	36-44cm	19-24cm	T-26155	T-26165	M 16-20cm 8-10cm
					T-26157	T-26167	L 20-25cm 10-12cm



Elastic Elbow Brace

- .Protect animal from elbow injuries; prevent strain to elbow muscle, tendon and ligament.
- .Rehabilitation assistance for elbow operation.
- .Superior elastic material allows comfortable movement of elbow.
- .Fix and support the animal; relieve the pain.

Code	Size	Upper arm girth	Forearm girth	Code	Size	Upper arm girth	Forearm girth
<i>medium-style dogs</i>				<i>small-style dogs, cats</i>			
T-23013	S	20-24cm	12-14cm	T-23112	XS	8-11cm	6-8cm
T-23015	M	24-28cm	14-16cm	T-23113	S	11-14cm	7-9cm
T-23017	L	28-32cm	16-20cm	T-23115	M	14-17cm	8-10cm
				T-23117	L	17-20cm	10-12cm



Elastic Knee Brace

- .Protect animal from knee injuries; prevent strain to knee muscle, tendon and ligament.
- .Rehabilitation assistance for knee operation.
- .Superior elastic material allows comfortable movement of knee.
- .Fix and support the animal; relieve the pain.

Code	Size	Upper leg girth	Lower leg girth	Code	Size	Upper leg girth	Lower leg girth
<i>medium-style dogs</i>				<i>small-style dogs, cats</i>			
T-26703	S	22-28cm	10-14cm	T-26712	XS	9-13cm	6-8cm
T-26705	M	28-36cm	14-19cm	T-26713	S	13-17cm	7-9cm
T-26707	L	36-44cm	19-24cm	T-26715	M	16-20cm	8-10cm
				T-26717	L	20-25cm	10-12cm



Adjustable Elbow Splint



- .Support and protection splint for elbow joint injuries, elbow joint arthritis, forelimb paresis, muscle strain, and reset of elbow joint dislocation during the rehabilitation period.
- .Adjustable range of motions allow fixation and support at a desired angle, or limit motion of elbow joint during the rehabilitation period.
- .Half-wrapped design, elastic foam lining, and hook-and-loop closures ensure perfect fixation.
- .Fix and support the animal; adjust and correct gait; relieve the pain.

Code	Size	Upper arm girth	Forearm girth
<i>medium-style dogs</i>			
T-22013	S	20-24cm	12-14cm
T-22015	M	24-28cm	14-16cm
T-22017	L	28-32cm	16-20cm

Code	Size	Upper arm girth	Forearm girth
<i>small-style dogs, cats</i>			
T-22022	XS	8-11cm	6-8cm
T-22023	S	11-14cm	7-9cm
T-22025	M	14-17cm	8-10cm
T-22027	L	17-20cm	10-12cm



Adjustable Knee Splint



- .Support and protection splint for knee joint injuries, knee joint arthritis, hindlimb paresis, muscle strain, and reset of knee joint dislocation during the rehabilitation period.
- .Adjustable range of motion allows fixation and support at a desired angle, or limit motion of knee joint during the rehabilitation period.
- .Half-wrapped design, elastic foam lining, and hook-and-loop closures ensure perfect fixation.
- .Fix and support the animal; adjust and correct gait; relieve the pain.

Code	Size	Upper leg girth	Lower leg girth
<i>medium-style dogs</i>			
T-27013	S	22-28cm	10-14cm
T-27015	M	28-36cm	14-19cm
T-27017	L	36-44cm	19-24cm

Code	Size	Upper leg girth	Lower leg girth
<i>small-style dogs, cats</i>			
T-27022	XS	9-13cm	6-8cm
T-27023	S	13-17cm	7-9cm
T-27025	M	16-20cm	8-10cm
T-27027	L	20-25cm	10-12cm

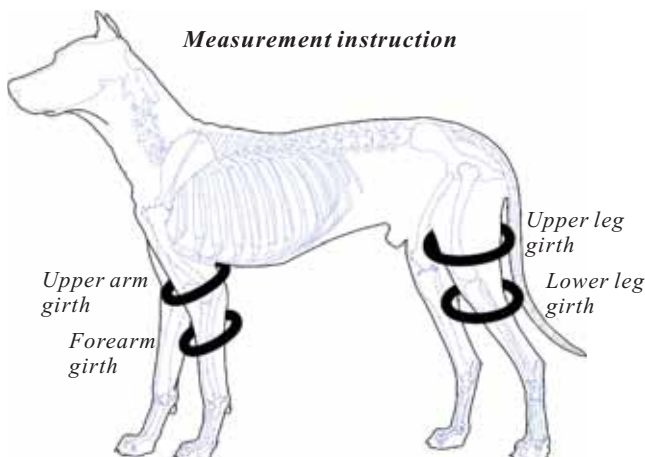

Measurement instruction

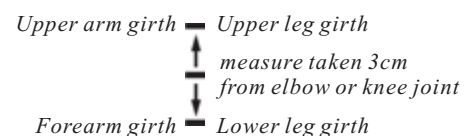



Fixing Carpal Splint 🐶 🐱

.Used on animal's radioulna, carpal and metacarpal.
 .Fixation of metacarpal fracture and carpal dislocation; correct, support and protect animal's forelimb.
 .Postoperative rehabilitation assistance of tendon and ligament injuries, carpal arthritis.
 .One-piece and half-surrounded splint, elastic foam lining and hook-and-loop fastener ensure secure fixation and comfortable fit.

Code	Size	Carpal girth	Splint length	Code	Size	Carpal girth	Splint length
<i>medium-style dogs</i>				<i>small-style dogs, cats</i>			
T-30302	XS	9-10cm	15cm	T-30312	XS	6-8cm	8cm
T-30303	S	10-11.5cm	18.5cm	T-30313	S	7-9cm	9cm
T-30305	M	11.5-12.5cm	20cm	T-30315	M	8-10cm	10cm
T-30307	L	12.5-14cm	21.5cm	T-30317	L	9-11cm	11cm
T-30308	XL	14-15.5cm	22cm				



Adjustable Carpal Splint 🐶 🐱

.Fixation and auxiliary post-op rehabilitation splint for metacarpal fractures, carpal joint dislocation, carpal joint arthritis, forelimb tendon and ligament ruptures.
 .Adjustable range of motions allow fixation and support at a desired angle, or limit motion of carpal joint during the rehabilitation period.
 .Fixation of metacarpal fracture and carpal dislocation; correct, support and protect animal's forelimb.
 .Half-wrapped design, elastic foam lining, and hook-and-loop closures ensure perfect fixation.

Code	Size	Carpal girth	Splint length	Code	Size	Carpal girth	Splint length
<i>medium-style dogs</i>				<i>small-style dogs, cats</i>			
T-30322	XS	9-10cm	15cm	T-30332	XS	6-8cm	8cm
T-30323	S	10-11.5cm	18.5cm	T-30333	S	7-9cm	9cm
T-30325	M	11.5-12.5cm	20cm	T-30335	M	8-10cm	10cm
T-30327	L	12.5-14cm	21.5cm	T-30337	L	9-11cm	11cm
T-30328	XL	14-15.5cm	22cm				

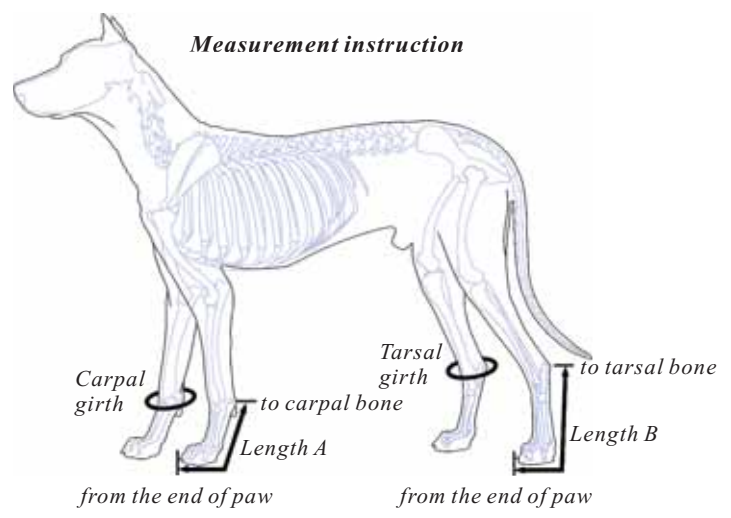



Bendable Carpal Brace



.Used on animal's radius, ulna, carpal and metacarpal.
 .Fixation and postoperative rehabilitation of carpal dislocation, radioulna fracture, tendon and ligament injuries and carpal arthritis; correct, support and protect animal's forelimb.
 .Bendable aluminum plate adjusts to carpal angle; hook-and-loop fastener allows secure and comfortable fit.
.Warning: When the inner aluminum plate is being shaped, it should be in arc and shaped gradually.

Code	Size	Carpal girth	Brace length	Code	Size	Carpal girth	Brace length	Code	Size	Carpal girth	Brace length
<i>medium-style dogs</i>				<i>small-style dogs, cats</i>				<i>big-style dogs</i>			
T-31102	XS	9-11cm	7cm	T-31112	XS	6-8cm	6cm	T-31123	S	17-19cm	16.5cm
T-31103	S	11-13cm	9cm	T-31113	S	7-9cm	6cm	T-31125	M	18-20cm	18cm
T-31105	M	13-15cm	11cm	T-31115	M	8-10cm	7cm	T-31127	L	19-21cm	20.5cm
T-31107	L	15-17cm	13cm	T-31117	L	9-11cm	8cm				
T-31108	XL	17-19cm	15cm								



Elastic Carpal Brace



.Protect animal from carpal injuries; prevent strain to carpal muscle, tendon and ligament.
 .Rehabilitation assistance for carpal operation.
 .Superior elastic material allows comfortable movement of carpal.
 .Fix and protect animal's forelimb; relieve pain.

Code	Size	Carpal girth	Brace length	Code	Size	Carpal girth	Brace length
<i>medium-style dogs</i>				<i>small-style dogs, cats</i>			
T-32803	S	11-13cm	13cm	T-32812	XS	6-8cm	6.5cm
T-32805	M	13-15cm	14.5cm	T-32813	S	7-9cm	6.5cm
T-32807	L	15-17cm	16.5cm	T-32815	M	8-10cm	7.5cm
T-32808	XL	17-19cm	18cm	T-32817	L	9-11cm	8.5cm



Bendable Hock Brace



.Used on animal's fibula, tibia, tarsal and metatarsal.
 .Fixation and postoperative rehabilitation of hock dislocation, tibiofibula fracture, tendon and ligament injuries and hock arthritis; correct, support and protect animal's hind limb.
 .Bendable aluminum plate adjusts to hock angle; hook-and-loop fastener allows secure and comfortable fit.
.Warning: When the inner aluminum plate is being shaped, it should be in arc and shaped gradually.

Code	Size	Tarsal girth	Brace length	Code	Size	Tarsal girth	Brace length	Code	Size	Tarsal girth	Brace length
<i>medium-style dogs</i>				<i>small-style dogs, cats</i>				<i>big-style dogs</i>			
T-31202	XS	10-12cm	15cm	T-31212	XS	6-8cm	9cm	T-31223	S	18-21cm	24.5cm
T-31203	S	12-14cm	18cm	T-31213	S	7-9cm	11cm	T-31225	M	20-23cm	27.5cm
T-31205	M	14-16cm	21cm	T-31215	M	8-10cm	13cm	T-31227	L	22-25cm	27.5cm
T-31207	L	16-18cm	23cm	T-31217	L	9-11cm	15cm				
T-31208	XL	18-20cm	25cm								



Hindlimb Dorsi-Flex Assist



.Used for animal with proprioceptive neurological disorders, tendon injuries, or lesion of the extensors of the paws.
 .Help the animal to walk with unstable or weak hindlimbs.
 .Help the flexion-extension movement while supporting the hindlimb; reduce slipping and walking on the back of the paw.
 .Reduce the stress on the knee joint when the animal is standing or walking.

Code	Size	Tarsal girth	Paw length x width	Code	Size	Tarsal girth	Paw length x width
<i>medium-style dogs</i>				<i>small-style dogs, cats</i>			
T-32503	S	10-12cm	60 x 77 mm	T-32512	XS	6-8cm	45 x 50 mm
T-32505	M	12-14.5cm	65 x 84 mm	T-32513	S	7-9cm	45 x 56 mm
T-32507	L	14.5-17cm	70 x 90 mm	T-32515	M	8-10cm	50 x 63 mm
T-32508	XL	17-20cm	75 x 97 mm	T-32517	L	9-11cm	55 x 70 mm



Wheeled Forelimb Orthosis



.Prevent the animal with carpal lesion to walk with the back of their paws; protect the forelimb from friction against the ground.
 .Help the animal to walk with weak or unstable forelimb or front paw.
 .Fix and straighten the forelimb according to the actual need.

Code	Size	Carpal girth	Length A	Code	Size	Carpal girth	Length A
<i>medium-style dogs</i>				<i>small-style dogs</i>			
T-32703	S	10-12cm	10.5-12.5cm	T-32712	XS	6-8cm	6-8cm
T-32705	M	12-14cm	12.5-14.5cm	T-32713	S	7-9cm	7-9cm
T-32707	L	14-16cm	14.5-17.5cm	T-32715	M	8-10cm	8-10cm
T-32708	XL	16-18cm	17.5-20.5cm	T-32717	L	9-11cm	9-11cm

Measurement instruction

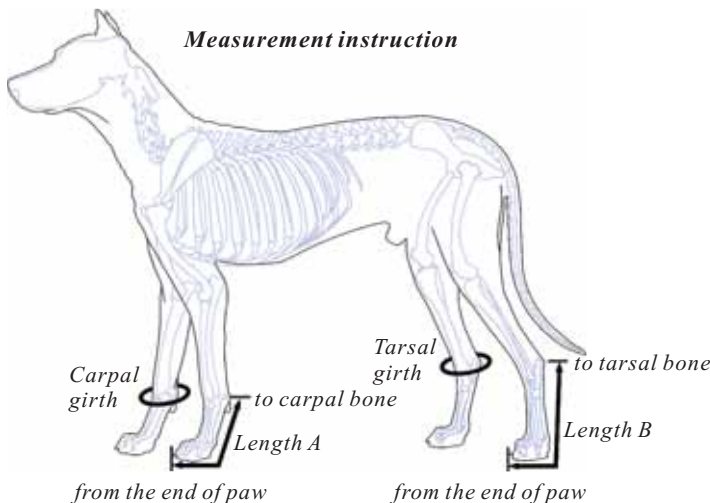



Protective Forelimb Prosthesis



.Used for animal with forelimb amputation below carpal joint.
 .The half-surrounded outer shell is strong enough to support and protect animal's leg.
 .Adjustable hinge on the carpal part allows free movement of carpal joint, avoiding related diseases, contributing to the functional recovery of carpal joint.
 .*Note: 1. Wrap the amputated limb with cotton bandages (not included in our products) before putting on the prosthesis, to ensure safer fixation and less bruise.
 2. Help the animal to walk or run on flat ground. The prosthesis may get loose if run too fast or on rough road.*

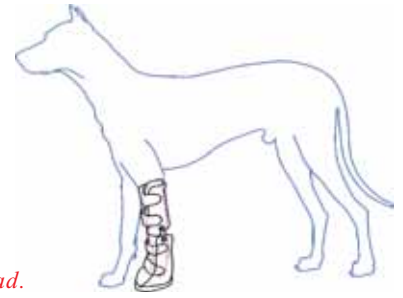

Code	Size	Length A	Carpal girth	Code	Size	Length A	Carpal girth
<i>medium-style dogs</i>				<i>small-style dogs, cats</i>			
T-33102	XS	10.5-12.5cm	9-10cm	T-33112	XS	7-9cm	6-8cm
T-33103	S	12.5-14.5cm	10-11.5cm	T-33113	S	8-10cm	7-9cm
T-33105	M	14.5-16.5cm	11.5-12.5cm	T-33115	M	9-11cm	8-10cm
T-33107	L	16.5-18.5cm	12.5-14cm	T-33117	L	10-12cm	9-11cm
T-33108	XL	18.5-20.5cm	14-15.5cm				



Protective Hindlimb Prosthesis



.Used for animal with hindlimb amputation below tarsal joint.
 .The half-surrounded outer shell is strong enough to support and protect animal's leg.
 .Adjustable hinge on the tarsal part allows free movement of tarsal joint, avoiding related diseases, contributing to the functional recovery of tarsal joint.
 .*Note: 1. Wrap the amputated limb with cotton bandages (not included in our products) before putting on the prosthesis, to ensure safer fixation and less bruise.
 2. Help the animal to walk or run on flat ground. The prosthesis may get loose if run too fast or on rough road.*

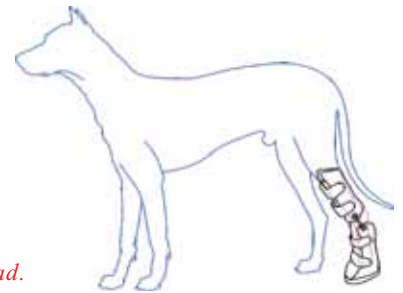

Code	Size	Length B	Tarsal girth	Code	Size	Length B	Tarsal girth
<i>medium-style dogs</i>				<i>small-style dogs, cats</i>			
T-33602	XS	12.5-16cm	10-12cm	T-33612	XS	8-11cm	6-8cm
T-33603	S	14.5-18cm	12-14cm	T-33613	S	9-12cm	7-9cm
T-33605	M	17.5-21cm	14-16cm	T-33615	M	10-13cm	8-10cm
T-33607	L	20.5-24.5cm	16-18cm	T-33617	L	12-15cm	9-11cm
T-33608	XL	24.5-28.5cm	18-20cm				

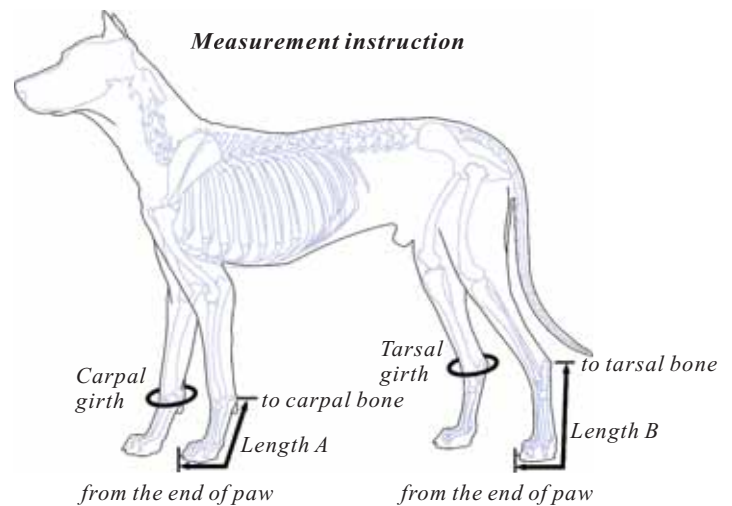



Supportive Forelimb Prosthesis



.Used for animal with forelimb amputation.
 .The strong outer shells, with two half-surrounded shells one covered by another, protect and support the amputated limb.
 .The adjustable aluminum support is lightweight and with high strength.
 .The TPR sole is hard-wearing and relieves shock.

- Note:* 1. The remaining radioulna after amputation shall be over 2/3 of the full. Or, we will suggest our wheelchair instead of prosthesis.
 2. Wrap the amputated limb with cotton bandages (not included in our products) before putting on the prosthesis, to ensure safer fixation and less bruise.
 3. Help the animal to walk or run on flat ground. The prosthesis may get loose if run too fast or on rough road.

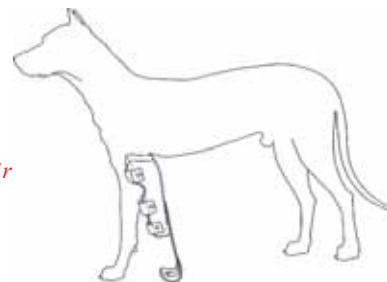

Code	Size	Forearm girth	Code	Size	Forearm girth
<i>medium-style dogs</i>			<i>small-style dogs, cats</i>		
T-33203	S	12-14cm	T-33213	S	6-8cm
T-33205	M	14-16cm	T-33215	M	7-9cm
T-33207	L	16-20cm	T-33217	L	8-10cm
			T-33218	XL	10-12cm



Supportive Hindlimb Prosthesis



.Used for animal with hindlimb amputation.
 .The strong outer shells, with two half-surrounded shells one covered by another, protect and support the amputated limb.
 .The adjustable aluminum support is lightweight and with high strength.
 .The TPR sole is hard-wearing and relieves shock.

- Note:* 1. The remaining tibiofibula after amputation shall be over 2/3 of the full. Or, we will suggest our Wheelchair instead of prosthesis.
 2. Wrap the amputated limb with cotton bandages (not included in our products) before putting on the prosthesis, to ensure safer fixation and less bruise.
 3. Help the animal to walk or run on flat ground. The prosthesis may get loose if run too fast or on rough road.

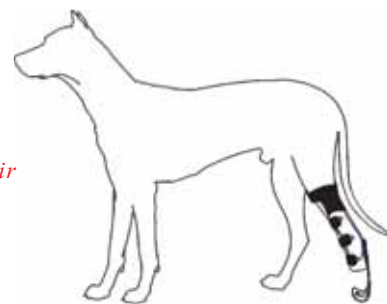

Code	Size	Lower leg girth	Code	Size	Lower leg girth
<i>medium-style dogs</i>			<i>small-style dogs, cats</i>		
T-33703	S	10-14cm	T-33713	S	6-8cm
T-33705	M	14-19cm	T-33715	M	7-9cm
T-33707	L	19-24cm	T-33717	L	8-10cm
			T-33718	XL	10-12cm

Measurement instruction

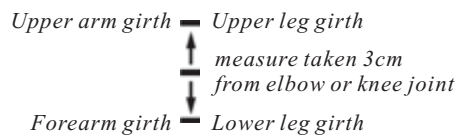
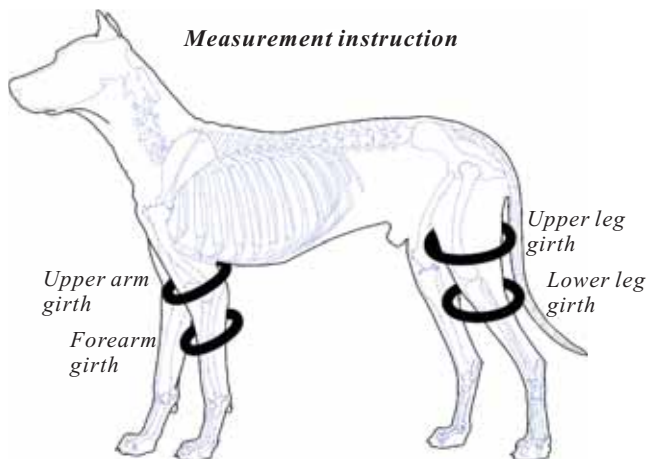



Outdoor Protection Boot



- .Offer optimum protection for animal's paws from injuries in the outdoors.
- .Antiwear and antislip design on rubber sole allows animal's fast movement in all conditions.
- .Thermal material, special sealing design, carpal/ankle-high upper allows optimum warmth, waterproof and stain repellent.
- .Conforming to the contour and special shape of animal paw allows optimum fit.
- .Available in variable sizes allows the suitable one for animal.
- .Reflective straps ensure visibility of animal in darkness.
- .Sold in a set of 4 pieces.

Code	Size	Length x Width
<i>small-style dogs, cats</i>		
T-35032	XS	45 x 50 mm
T-35033	S	45 x 56 mm
T-35034	M	50 x 63 mm
T-35035	L	55 x 70 mm

Code	Size	Length x Width
<i>medium-style dogs</i>		
T-35052	S	60 x 77 mm
T-35053	M	65 x 84 mm
T-35054	L	70 x 90 mm
T-35055	XL	75 x 97 mm

Code	Size	Length x Width
<i>big-style dogs</i>		
T-35072	S	80 x 101 mm
T-35073	M	85 x 108 mm
T-35074	L	90 x 112 mm
T-35075	XL	95 x 119 mm



Outdoor Walking Shoe



- .Offer optimum protection for animal's paws from injuries in the outdoors.
- .Antiwear and antislip design on rubber sole allows animal's fast movement in all conditions.
- .Thermal material and special sealing design allows optimum warmth, waterproof and stain repellent.
- .Paw contoured design allows optimum fit.
- .Available in variable sizes allows the suitable one for animal.
- .Reflective straps ensure visibility of animal in darkness.
- .Sold in a set of 4 pieces.

Code	Size	Length x Width
<i>small-style dogs, cats</i>		
T-35132	XS	45 x 50 mm
T-35133	S	45 x 56 mm
T-35134	M	50 x 63 mm
T-35135	L	55 x 70 mm

Code	Size	Length x Width
<i>medium-style dogs</i>		
T-35152	S	60 x 77 mm
T-35153	M	65 x 84 mm
T-35154	L	70 x 90 mm
T-35155	XL	75 x 97 mm

Code	Size	Length x Width
<i>big-style dogs</i>		
T-35172	S	80 x 101 mm
T-35173	M	85 x 108 mm
T-35174	L	90 x 112 mm
T-35175	XL	95 x 119 mm

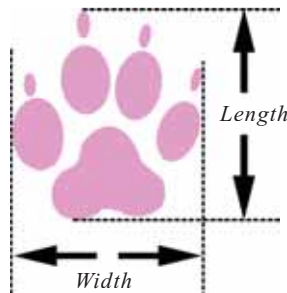



Protection Footwear



- .Protect animal's paws from injuries in bad conditions.
- .Comfortable fit, wearproof and warmth. Hook and loop fasteners ensure convenient closure and release.
- .Reflective straps ensure visibility of animal in darkness; lightweight; reusable.
- .Sold in a set of 4 pieces.

Code	Size	Width	Code	Size	Width	Code	Size	Width
<i>small-style dogs, cats</i>			<i>medium-style dogs</i>			<i>big-style dogs</i>		
T-35230	S	40 mm	T-35233	S	60 mm	T-35237	S	80 mm
T-35231	M	45 mm	T-35234	M	65 mm	T-35238	M	85 mm
T-35232	L	55 mm	T-35235	L	70 mm	T-35239	L	90 mm
			T-35236	XL	75 mm			



Outdoor Protection Boot



- .Offer optimum protection for animal's paws from injuries in the outdoor.
- .Antiwear and antislip design on rubber sole allows animal's fast movement in all conditions.
- .Breathable spacer fabric material allows air circulation and comfortability.
- .Available in variable sizes allows the suitable one for animal.
- .Reflective straps ensure visibility of animal in darkness.
- .Sold in a set of 4 pieces.

Code	Size	Length x Width	Code	Size	Length x Width	Code	Size	Length x Width
<i>small-style dogs, cats</i>			<i>medium-style dogs</i>			<i>big-style dogs</i>		
T-35332	XS	45 x 50 mm	T-35352	S	60 x 77 mm	T-35372	S	80 x 101 mm
T-35333	S	45 x 56 mm	T-35353	M	65 x 84 mm	T-35373	M	85 x 108 mm
T-35334	M	50 x 63 mm	T-35354	L	70 x 90 mm	T-35374	L	90 x 112 mm
T-35335	L	55 x 70 mm	T-35355	XL	75 x 97 mm	T-35375	XL	95 x 119 mm

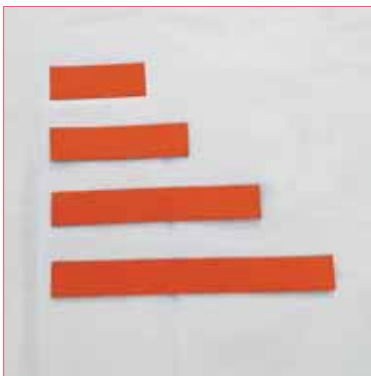

Bendable Fixation Splint



- .Fixation for animals with joints sprain and contusion; temporary fixation of fracture emergency.
- .Easy to cut and fold for a customized fit.
- .Bendable aluminum plate can be adjusted to fit different angles.

Code	Size
T-46001	5 x 20 cm
T-46002	5 x 30 cm
T-46003	5 x 40 cm
T-46004	10 x 20 cm
T-46009	whole set (4 sizes)

Taiwan Patent
China Patent



small-style dogs



medium-style dogs

Walking Wheelchair



- .Enable free movement of dogs with shoulder or hip dysplasia, osteoarthritis, protrusion of intervertebral disc, forelimb or hindlimb paralysis, spinal and neurological injuries. Support dogs in post-op rehabilitation period. Prevent muscle atrophy.
- .Support dogs with unwalkable forelimbs or hindlimbs. Enable free movement and natural gait.
- .Strong and lightweight aluminum frame. Help dogs to walk and jog on flat road.
- .Adjustable height, length and width allow the fit to different sizes of dogs.
- .Warning: The wheelchair may overturn if the dog runs too fast or on rough road.**

Code	Bearing weight	Dog body length	Dog body width	Dog height
<i>small-style dogs</i>				
T-40115	30kg	31-44.5cm	13-20cm	18-33cm

Code	Bearing weight	Dog body length	Dog body width	Dog height
<i>medium-style dogs</i>				
T-40125	40kg	41.5-66cm	20-27cm	33-58cm

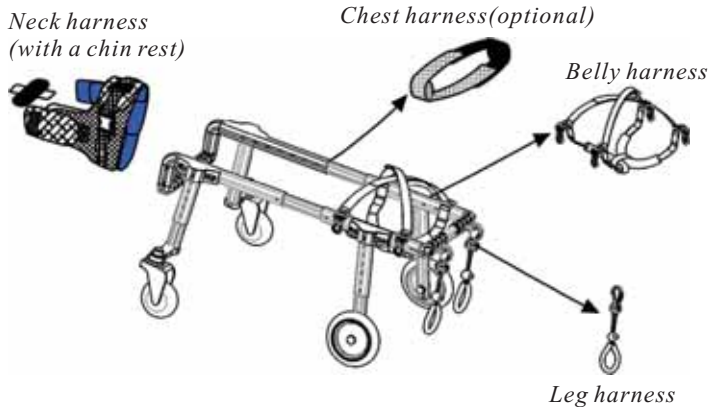

All the harnesses can be sold in sets.

1 set of harnesses contains:
neck harness (with a chin rest) x 1, belly harness x 1,
leg harness x 2, chest harness (optional) x 1

The codes are as follows:

T-40115-050 (small-style dogs)

T-40125-050 (medium-style dogs)

Taiwan Patent
China Patent



small-style dogs



medium-style dogs

Walking Forelimb Wheelchair



.Used for dogs with injured forelimb, forelimb amputation, forelimb malformation and forelimb mobility inconvenience caused by brain damage.

.The wheelchair work as dog's forelimbs. It helps to prevent the damage to dog's spine and hindlimbs' joints.

.The special design allows the dog to sit down or lower its head to ground.

.Strong and lightweight aluminum frame. Help dogs to walk and jog on flat road.

.Adjustable height, length and width allow the fit to different sizes dogs.

.Warning: The wheelchair may overturn if the dog runs too fast or on rough road.

Code	Bearing weight	Dog body length	Dog body width	Dog height
<i>small-style dogs</i>				
T-40213(short-legged)	30kg	31-44.5cm	13-20cm	16-30cm
T-40215	30kg	31-44.5cm	13-20cm	18-33cm

Code	Bearing weight	Dog body length	Dog body width	Dog height
<i>medium-style dogs</i>				
T-40223(short-legged)	40kg	41.5-66cm	20-27cm	23-48cm
T-40225	40kg	41.5-66cm	20-27cm	33-58cm



Neck harness
(with a chin rest)

Chest harness(optional)

Belly harness
(with a back pad)

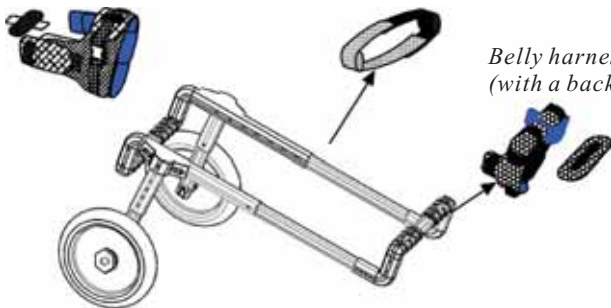

All the harnesses can be sold in sets.

1 set of harnesses contains:

- neck harness(with a chin rest) x 1,
- belly harness(with a back pad) x 1,
- chest harness (optional) x 1

The codes are as follows:

- T-40213-050(small-style dogs, short-legged)
- T-40215-050(small-style dogs)
- T-40223-050(medium-style dogs, short-legged)
- T-40225-050(medium-style dogs)



Vacuum Shaping Mattress

- Temporary fixation for animals in fracture emergency.
- Wrap the animal according to its size, contour and posture required.
- X-ray transparent.

Code	Size	Bearing weight
T-43101	1 set (S+pump+bag) S: 50 x 75 cm	20kg
T-43102	1 set (M+pump+bag) M: 60 x 90 cm	35kg
T-43103	1 set (L+pump+bag) L: 76.7 x 115 cm	50kg
T-43109	whole set (S+M+L+pump+bag)	



Transfer Sheet

- Transfer and transportation of injured animals.
- Waterproof material resists blood leakage.
- Lightweight and foldable material allows easy carry.
- Handles for easy grasp; adjustable strap helps to fix the animal.

Code	Size	Bearing weight
T-43200	128 x 70 cm	100kg



Disaster Pouch

- Package, transportation and burying of dead bodies.
- Waterproof material resists liquid leakage and germ spreading.
- High frequency sealing prevents unpleasant smell.
- A long side zip allows quick package.

Code	Size	Bearing weight
T-43300	128 x 70 cm	70kg



Emergency Stretcher

- Transfer and transportation of injured animals.
- Easy to clean; Strong bearing strength.
- Straps to fix animals in transportation.
- Lightweight; easy for storage and carry.

Code	Size	Bearing weight
T-43400	128 x 60 cm	150kg



Clinic Mobile Wheelchair

- Appropriate for quadriplegic or weak animals – wobblers syndrome, temporary tick paralysis, post-operative mobilization and transport.
- For animals with severe trauma.
- Easy to clean, can be used as a sickbed.
- The length and height can be adjusted.
- The height can be adjusted from 35cm to 75cm at the pelvis floor.
- Apply to animals with length from 50cm to 100cm.
- The electroplating surface is easy to slide and adjust.

Code	Height range	Length range	Bearing weight
T-43500	35-75cm	50-100cm	65 kg



Measuring Tap

- For veterinarians to take the measure of animals in different positions.

Code
T-48010

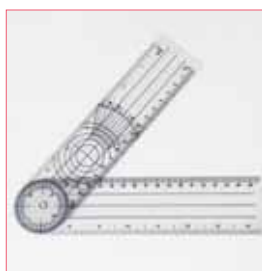

Goniometer

- Take the angle of joints bending and extension before or after surgery, or in physiotherapy.
- 360° degrees available.

Code
T-48020



Inflatable Peanut-shape Ball



- .Boost confidence.
- .Improve health.
- .Strengthen coordinate ability.
- .Build strength.
- .Promote better body form.
- .Strengthen the animal's sense of balance and body awareness.
- .Help the animal to stand independently.
- .Relieve the animal's psychological fear.
- .Food can be used to encourage the animal to move when practicing.
- .Practice 10 to 20 minutes per day, or under the veterinarian's direction.

Code Size(length x width)

T-47101	40 x 20cm
T-47102	50 x 25cm
T-47103	60 x 30cm
T-47104	70 x 35cm
T-47105	80 x 40cm
T-47106	90 x 45cm

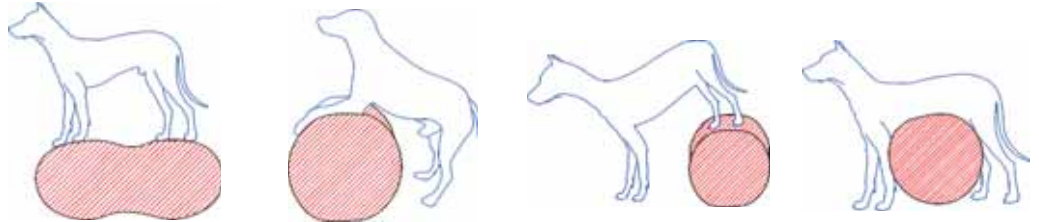

Inflatable Balance Ball



- .Boost confidence.
- .Improve health.
- .Strengthen coordinate ability.
- .Build strength.
- .Strengthen the animal's sense of balance.
- .Tools for rehabilitation or physical therapy.
- .Help the animal to practice which are not able to walk or stand independently.
- .Relieve the animal's psychological fear.
- .Food can be used to encourage the animal to move when practicing.
- .Practice 10 to 20 minutes per day, or under the veterinarian's direction.

Code Diameter

T-47111	45cm
T-47112	55cm
T-47113	65cm
T-47114	75cm
T-47115	85cm

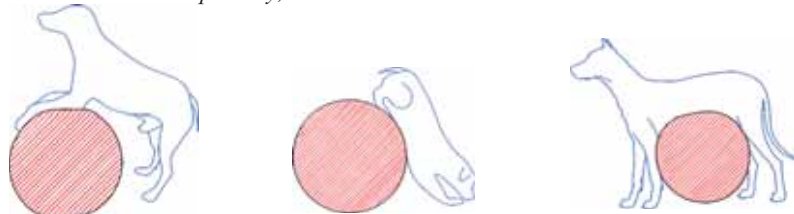

Inflatable Balance Cushion



- .Perfect for early stage balance practice.
- .Used for whole body fitness.
- .For rehabilitation use.
- .Strengthen the animal's core and limbs.
- .Strengthen the animal's sense of balance and body awareness.
- .Textured surface stimulates the nervus.
- .Practice 10 to 20 minutes per day, or under the veterinarian's direction.

Code Diameter

T-47120	33cm
---------	------

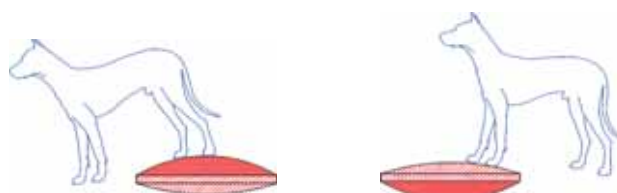



Four-wheel Sliding Board



- .Boost confidence.
- .Strengthen body awareness.
- .Strengthen the animal's sense of balance.
- .Exercise and strengthen animal's body.
- .Four universal wheels on the bottom allow all direction movement.
- .Made of wood with slide-proof surface.
- .Relieve the animal's psychological fear.
- .Food can be used to encourage the animal to move when practicing.
- .Practice 10 to 20 minutes per day, or under the veterinarian's direction.

Code	Size(length x width x height)
T-47155	80 x 60 x 8cm
T-47156	60 x 40 x 8cm



Seesaw Balance Board



- .Boost confidence.
- .Strengthen body awareness.
- .Strengthen the animal's sense of balance.
- .Exercise and strengthen animal's body.
- .Wooden with slide-proof surface.
- .Work like a seesaw with a pole in the right middle.
- .Relieve the animal's psychological fear.
- .Food can be used to encourage the animal to move when practicing.
- .Practice 10 to 20 minutes per day, or under the veterinarian's direction.

Code	Size(length x width x height)
T-47165	80 x 60 x 8cm
T-47166	60 x 40 x 8cm



Round Balance Board



- .Rotate a full 360.
- .Improve the animal's sense of all direction balance.
- .Strengthen body awareness.
- .Wooden with slide-proof surface.
- .Exercise and strengthen animal's body.
- .Wooden with slide-proof surface.
- .Round shape with a fulcrum in the right middle.
- .Relieve the animal's psychological fear.
- .Food can be used to encourage the animal to move when practicing.
- .Practice 10 to 20 minutes per day, or under the veterinarian's direction.

Code	Size(diameter x height)
T-47175	Φ 60 x 8cm
T-47176	Φ 80 x 8cm



Straight line rush or jump



"S" rush or jump



"S" rush

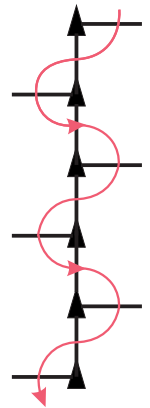

Code
T-47180

Agility Exercise Kit



- .Agility Exercise Kit
- .Improve gait movement and body agility.
- .Improve the animal's limbs coordination; strengthen the animal's sense of balance and body awareness.
- .Improve cardiopulmonary sufficiency.
- .Three heights for option.
- .Different exercises can be taken by different assembly.
- .Better to jump slowly at first, then with a faster speed.
- .Practice 10 to 205 minutes per day, or under the veterinarian's direction.
- .Lightweight and easy to carry.



Handling Exercise Support



- .Limit the animal's motion.
- .Support animal's key positions.
- .Help the animal to keep stable when moving.
- .Assist the animal to move up and down when practicing.
- .Help the animal to avoid getting hurt.
- .The adjustable high-intensity strap ensures better fit. The strap on the chest help to ensure the animal's safety.



Handling Exercise Support



- .Limit the animal's motion.
- .Support animal's key positions.
- .Help the animal to keep stable when moving.
- .Assist the animal to move up and down when practicing.
- .Help the animal to avoid getting hurt.
- .The adjustable high-intensity strap ensures better fit. The strap on the chest help to ensure the animal's safety.

Code	Size	Chest girth	Animal style
T-47503	S	30-55cm	small-style dogs, cats
T-47505	M	55-87cm	medium-style dogs
T-47507	L	87-110cm	big-style dogs

Code	Size	Chest girth	Animal style
T-47513	S	30-55cm	small-style dogs, cats
T-47515	M	55-87cm	medium-style dogs
T-47517	L	87-110cm	big-style dogs



Cool/Hot Wrap



- .The cool wrap is used for acute injury. It helps to diminish inflammation, relieve pain, reduce swelling and prevent the wound from expansion.
- .The hot wrap is used for blood congestion and swelling. It promotes blood circulation to reduce blood congestion and swelling.
- .Cool or hot for less than 20 minutes per time.
- .The fixing wrap keeps the cool/hot pack on the right position.

Code

T-47200



Weight Bar
100g

Weighted Body Vest



- .Used on the animal's body.
- .It challenges the muscle to improve the animal's strength.
- .Increase the intensity of training, reducing the training time.
- .Adjust the bearing weight according to the actual need.
- .Weight bar can be put into the vest, with per weight of 100g.
- .20 bars can be put into T-47303 to reach a maximum weight of 2.0kg; 36 bars can be put into T-47305 to reach a maximum weight which is 3.6kg



Weight Bar
100g

Weighted Limb Wrap



- .Used on the animal's limbs.
- .It challenges the muscle to improve the animal's strength.
- .Increase the intensity of training, reducing the training time.
- .Adjust the bearing weight according to the actual need.
- .Weight bar can be put into the wrap, with per weight of 100g.
- .3 bars can be put into T-47313 to reach a maximum weight of 300g; 8 bars can be put into T-47315 to reach a maximum weight of 800g; 11 bars can be put into T-47317 to reach a maximum weight which is 1100g.

Code	Chest girth	Max bearing weight
T-47303	30-50cm	2.0kg (100gx20bars)
T-47305	50-100cm	3.6kg (100gx36bars)

Code	Size	Max bearing weight
T-47313	8x12cm	300g(100gx3bars)
T-47315	15x20cm	800g(100gx8bars)
T-47317	20x25cm	1100g(100gx11bars)

Purchase and Directions of Use for Veterinarians

1. *Veterinarians shall make sure to measure the animals and choose the right size according to the measurement direction and size chart on the catalogue.*
2. *Our products are not customized. If the size doesn't fit your patient, please return the goods within 10 days after receipt of products, with the products clean, and package and accessories completed (Only the payment for the products will be returned, freight is not included). Or, we are not responsible for the problems followed. Invoices will be issued after your decision to buy the products.*
3. *The products shall be applied to the patient after the release of inflammation and swelling on wounds or sprains. Or the veterinarians can decide when to use the products. Special attention shall be paid to the wounds and sprains during the application period.*
4. *The patients' owners shall be reminded of the warnings on the catalogue and user instruction, and be very careful during the application period.*
5. *Veterinarians shall urge owners to use the products according to the usage steps on the user instruction.*
6. *The patients shall be revisited in the first week of application.*
 - A. *It is natural that the patient will be terrified and resist the product, so more patience should be devoted to train the patient to adapt to the products.*
 - B. *To induce the patient with the food it likes is a good way in the initial stages of using.*
 - C. *The application time shall be gradually extended or deepend in the initial stages of using.*
 - D. *When to use the products and if the products should be used at rest are up to the professional veterinarians' direction.*
 - E. *Ensure that the products are used in the correct position.*
7. *Suggestions to improve our products structure and function are highly appreciated.*
8. *We don't offer service to animal owners. Only selling prices to the owners are suggested for your reference only.*

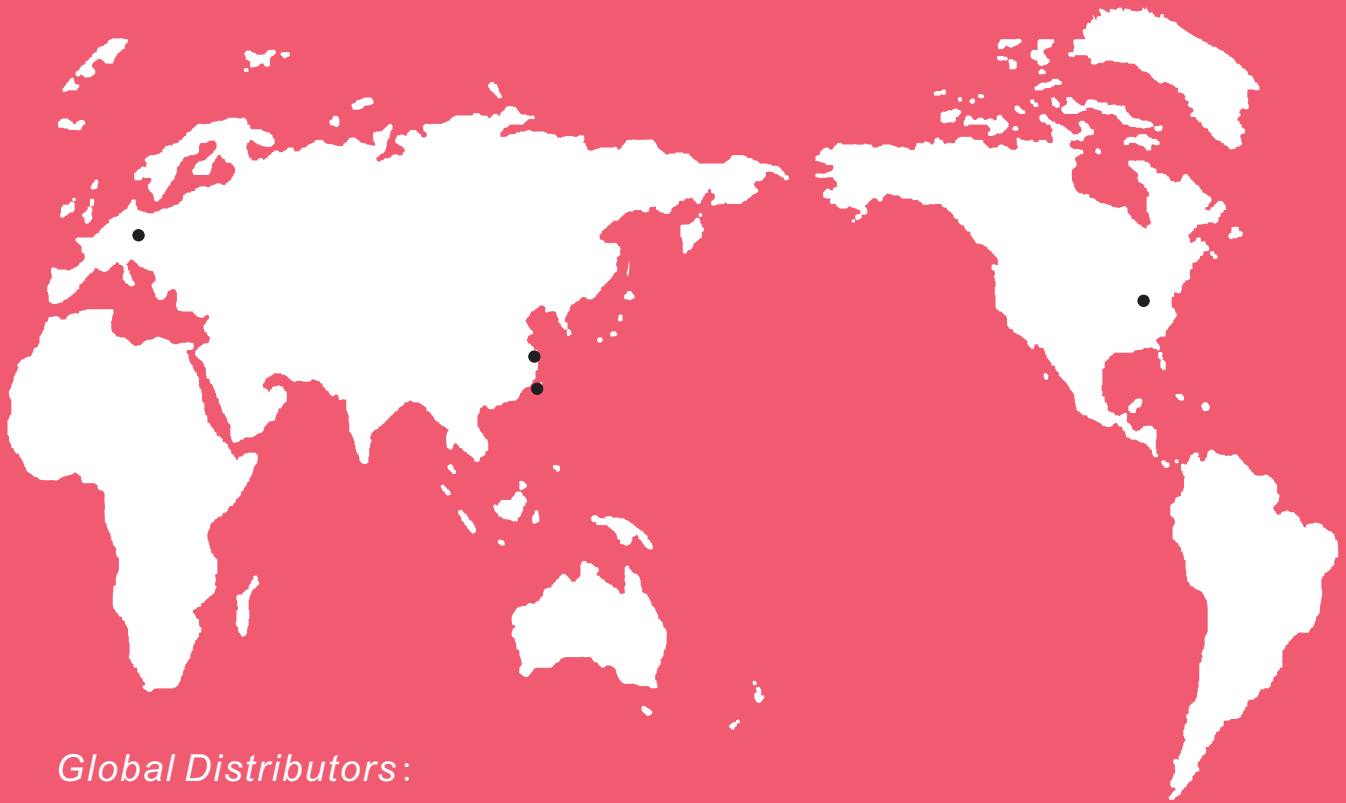

Global Distributors:

Europe:

***inocare Medical GmbH
Tel: +49 6226 7873 223
E-Mail: animal@inocare.de***

Taiwan:

***Dobest Medical International Trading Co., Ltd.
Tel: +886-6-2682292
E-Mail: sales@dbmco.com.tw***

China:

***Medi Trading (Shanghai) Co., Ltd.
Tel: +86-21-39527088
Mobile: +86-17351242850
E-Mail: export@medioem.com***

America:

***Triple Inc.
Tel: 1-574-2671450
E-Mail: tripleinc@kconline.com***

Sole Distributors wanted in all countries !



Triad Orthopedic Products Industrial Co., Ltd.

***Tel: +886-6-2682277
Email: export@deltaigroup.com.tw
Website: www.triad-orthopedic.com
Add: An Ping Industrial Park, Tainan, Taiwan***

Website

